

BOOST QUICK GUIDE

MPR2 logO DATALOGGER



Quick Guide is not a replacement for Instructions For Use.
For detailed instructions refer to the MPR2 logO DATALOGGER and
NEUROVENT-PTO/PTO2L/TO IFU.

Cable Connections

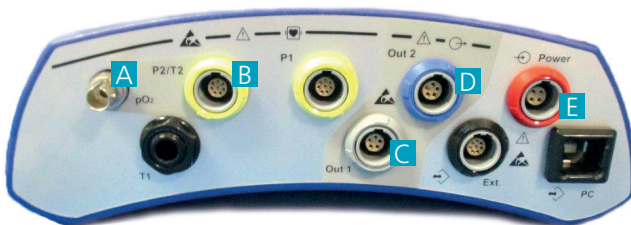

Cable LWL

Cable PTO

Cable DATALOGGER

Power Supply

- A** Remove grey cap and connect to the **Cable LWL**
- B** Connect **Cable PTO** to yellow connector
- C** Connect **Cable DATALOGGER** with grey ICP label to grey connector
- D** Connect **Cable DATALOGGER** with blue pO₂ label to blue connector
- E** Connect **Power Supply** to the red connector (Power Port)

Catheter Connections

Connection between catheter and Cable LWL

Step 1: Insert the tongue into the groove



Step 2: Turn the connector until it locks

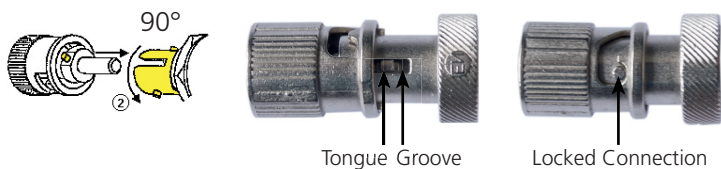

Connection between catheter and Cable PTO



Start Screen

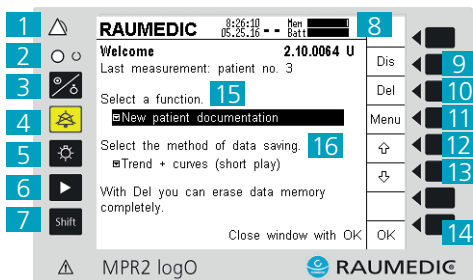

- 1 Alarm LED
- 2 LED Power ON
- 3 ON/OFF Key
Press and hold to turn on/off
- 4 Switches Audio off
- 5 Switches Background lighting on/off
- 6 Changes Display Screen
- 7 Toggle Key
- 8 Mem: Available Memory
Batt: Battery Charge
- 9 Display Configuration
- 10 Delete
- 11 Selection
- 12 Navigate up
- 13 Navigate down
- 14 Confirmation
- 15 Create a New Patient
- 16 Select Memory Mode

Device Settings

- 1.) To start a new measurement, select „New patient“ and press „OK“.

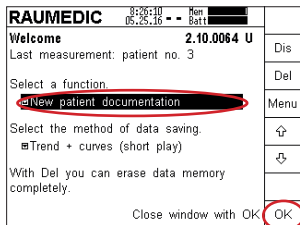

- Continue Monitoring Current Patient Press 'Menu'. Select 'Continue measurement'. Confirm Press 'OK'.

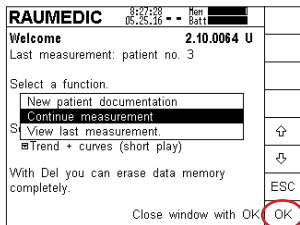

2. Select Alarm Limit

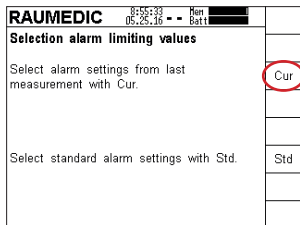

Select 'Cur', for last applied alarm settings.

Select 'Std', for manufacturer alarm settings.

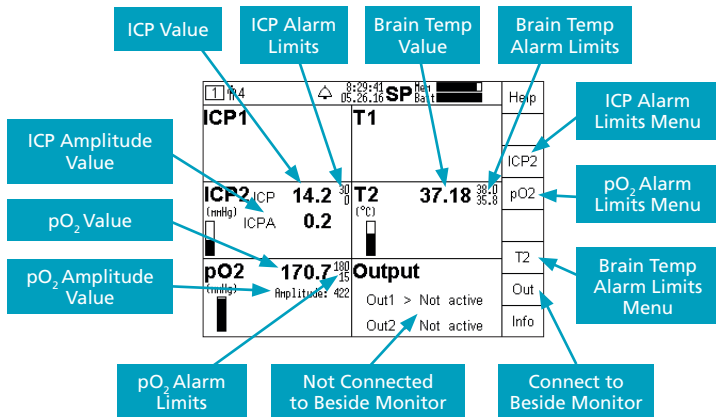

*If no alarm limits are displayed, the alarm has to be turned off.

$pO_2 = p_{iO_2} = p_{tO_2} = p_{brO_2}$

Connecting to Beside Monitor

1. Select 'OUT'
2. Connect Datalogger cables to bedside monitor, then press 'OK'.

4 4		15:55:17		SP		Help	
ICP1		T1					
				ICP2			
ICP2 ICP 12.9		T2 37.51		pO2			
(mmHg) ICPA 0.3		(°C)					
pO2 137.9		Output		T2		Out	
(mmHg) Amplitude: 412		Out1 > inactive				Info	
		Out2 > inactive					

4 4		15:56:10		SP		Help	
Analogue output Out1 and Out2 Connect the cables to the bedside monitor. Press OK, in order to begin the configuration of the analogue output.							
Out1 > ICP2							
Out2 > pO2							
OK							
ESC							

3. Calibrate Bedside monitor. Zero bedside monitor according to manufacturer's instructions. Verify that the bedside monitor displays a numeric zero, then press 'OK'.

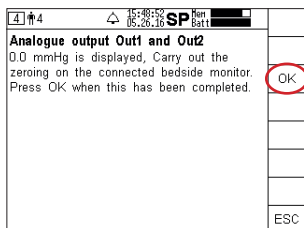

4. Calibration Test for Accuracy. To ensure proper communication 20mmHg \pm 2mmHg (18-22mmHg) should be displayed on the bedside monitor, then press 'OK'. If this value is not displayed repeat step 3 or plug Datalogger cable into new pressure port.

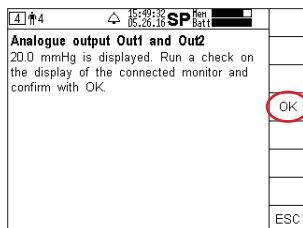

5. ICP2 and pO2 are now displayed on the bedside monitor, press 'OK'.

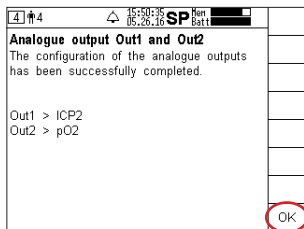

6. Output field displays Out1 and OUT2 active. ICP and pO2 values will be displayed on both the MPR2 and the bedside monitor.

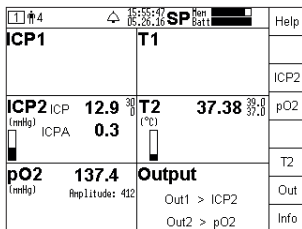

Device Memory Indicator

1. When memory is 50% full press 'OK'. Once memory is full the oldest data on monitor will be erased and it will continue to record.

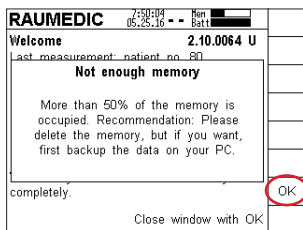

2. Once data has been saved to PC, press 'Del'. To erase all stored data press 'Shift' and 'Del' at the same time and all memory will be erased.

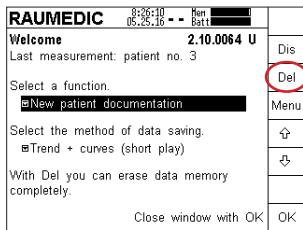

Error Messages

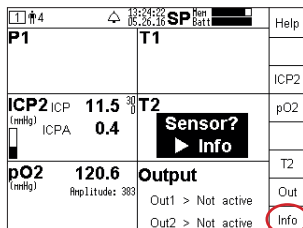
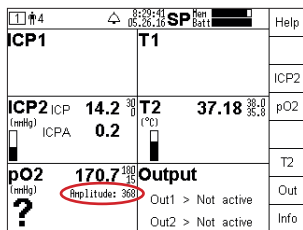

pO2?

Amplitude below 375

Clean Optical connections

(Cable LWL **A**) with alcohol wipe:

- between Cable LWL and catheter
- and between Cable LWL and socket **A** on MPR2 logO Data-logger

Sensor?

When Sensor? occurs, press 'Info' for additional information.

If cause cannot be remedied, switch off channel by pressing 'ICP2', 'pO2' or 'T2'.

Graphic Display

Screen Indicator

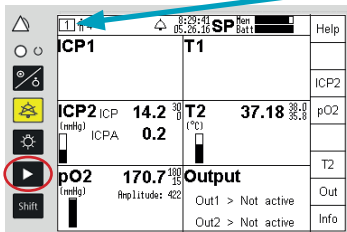

▶ Use to switch to graphic Display

Screen **1** Numeric Display
(current display)

Screen **2** Live Data

Screen **3** Trend Data

Screen **4** Device Settings

Troubleshooting Questionable O_2 Values

O_2 Reactivity test if oxygen values are questionable

- Oxygen Challenge: place patient at 100% FiO_2 for 10 min.
- No change in O_2 values
 - Check catheter placement by CT Scan
 - Slightly turn the catheter as blood may be on the oxygen window. (Blood on O_2 window will return low or no value for pO_2)

Threshold¹ $p_{ti}O_2$

Oxygen Monitoring $p_{ti}O_2$ denotes oxygen partial pressure in extracellular fluid of the brain. Normal brain oxygen 25-35 mmHg
20-15 mmHg treatment initiated

< 15 mmHg for more than 4 hr increased mortality

< 10 mmHg for more than 30 mins increased mortality or worsen outcome

¹Brain Trauma Foundation and the Joint Section of Neurotrauma and Critical Care of the American Association of Neurological Surgeons and the Congress of Neurological Surgeons: Guidelines for the Management of Severe Head Injury. Park Ridge, IL: Brain Trauma Foundation 2007

BOOST Firmware Settings

1. To start a new measurement, select „New patient“ and press „OK“
2. To blind pO2 select „pO2“

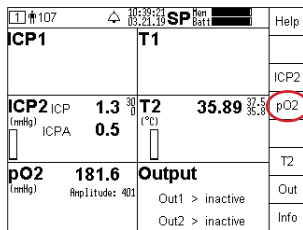
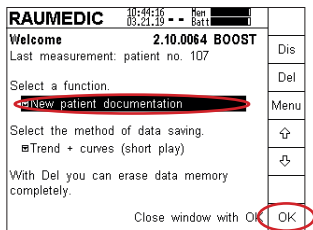

3. Select "Menu"
4. To Fully blind the pO2 value use the "down arrow" to select "NO" and press "OK"

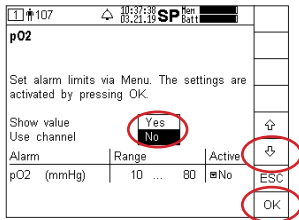
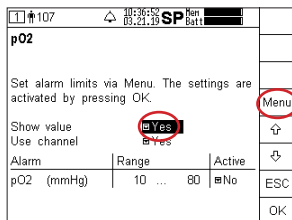

- After “NO” has been selected, the shown warning will appear. Please note that these settings will be saved even if the MPR2 is restarted. All of the alarm limits are turned off and need to be manually reactivated. After the warning has been read, press “OK” and the warning will disappear.
- The pO2 value is blinded, now a “REC” will appear to show that pO2 is still measured and recorded, but the pO2 value is not displayed. The Amplitude will still be shown to ensure that the catheter is functioning properly. The Amplitude should never be below a minimum of 375, an Amplitude of 400 is considered ideal.

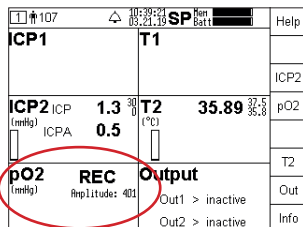
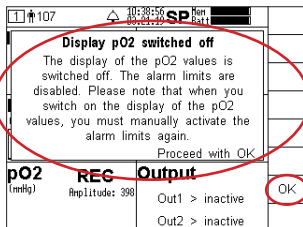

7. To turn pO2 Display on, repeat steps 2 and 3. Use “up arrow” to select “Yes” and press “OK”.

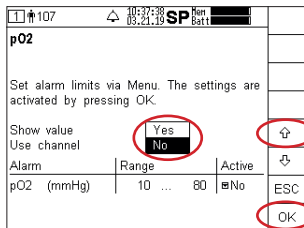

8. pO2 Value displayed.

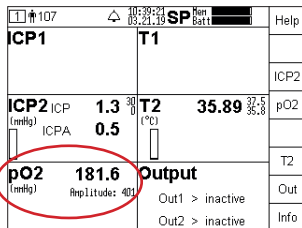

9. Screen 4 displays if either the pO2 value is displayed or blinded.

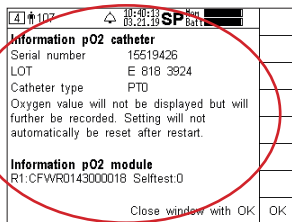

US Contact:

RAUMEDIC Inc.
 235 Broadpointe Dr
 Mills River, NC 28759

24 hr. support: 888 647 0070
 Fax: 516 224 3380
 www.raumedic.com